

EUROFLO[®]
CULVERT PIPE



EUROFLO[®] FITTINGS

JOINERS



SIZE	CODE	COMMENT
315mm	521-315	
400mm	521-400	
500mm	521-500	
630mm	521-630	
800mm	521-800	

REDUCERS



SIZE	CODE	COMMENT
315mm x 250mm	521-315-250	
400mm x 250mm	521-400-250	
400mm x 315mm	521-400-315	
500mm x 400mm	521-500-400	

BENDS AND JUNCTIONS



SIZE	CODE	COMMENT
315mm x 15°	571-315-15	M+F
315mm x 30°	571-315-30	M+F
315mm x 45°	521-315-45	
315mm x 90°	521-315-90	
400mm x 45°	521-400-45	
400mm x 45°	521-400-45J	Junction
400mm x 90°	521-400-90	
500mm x 45°	521-500-45	
500mm x 90°	521-500-90	
630mm x 22°	571-630-22	M+F
630mm x 45°	521-630-45	
630mm x 90°	521-630-90	
800mm x 22°	571-800-22	M+F
800mm x 45°	571-800-45	M+F
800mm x 88°	571-800-90	M+F

Note: Other fittings can be made to order

Key

All Item DWV unless noted
M+F = Male, Female Ends

DWV= Drain Waste and Vent
F+F= Female, Female Ends

SW= Storm Water
ADJ= Adjustable

SN4 RUBBER RINGS



SIZE	CODE	COMMENT
160mm OD	520-160-RBR	
200mm OD	520-200-RBR	
250mm OD	520-250-RBR	
315mm OD	520-315-RBR	
400mm OD	520-400-RBR	
500mm OD	520-500-RBR	
630mm OD	520-630-RBR	
800mm OD	520-800-RBR	
1000mm OD	520-1000-RBR	
1200mm OD	520-1200-RBR	

SN8 RUBBER RINGS



SIZE	CODE	COMMENT
250mm OD	560-250-RBR	
315mm OD	560-315-RBR	
400mm OD	560-400-RBR	
500mm OD	560-500-RBR	
630mm OD	560-630-RBR	
800mm OD	560-800-RBR	
1000mm OD	560-1000-RBR	
1200mm OD	560-1200-RBR	
1300mm OD	560-1300-RBR	
1500mm OD	560-1500-RBR	
1700mm OD	560-1700-RBR	
1900mm OD	560-1900-RBR	
2100mm OD	560-2100-RBR	

Note: Also known as sealing rings

Key

All Item DWV unless noted
M+F = Male, Female Ends

DWV= Drain Waste and Vent
F+F= Female, Female Ends

SW= Storm Water
ADJ= Adjustable

EUROFLO® GO-IN SYSTEM

COMPONENTS:

1. Holesaw and arbor
2. Sealing ring
3. Sealing adaptor (needed to connect pipes of 160mm and 200mm OD)
4. Sealing adaptor rubber ring gasket (needed to connect smooth PV or PE pipes of 160mm and 200mm OD)

BENEFITS:

- Branches can be simply installed after main pipe placement
- Extremely cost effective
- Can be installed vertically even when water is flowing
- Fast and user-friendly
- Adaptable for branches of either ribbed PE or smooth PVC

USES:

- Breather pipe connections
- Field drain connections to main drain
- Connections into sumps and galleries



INSTALLATION:

Drill through top centre of corrugation at right angles to pipe axis.

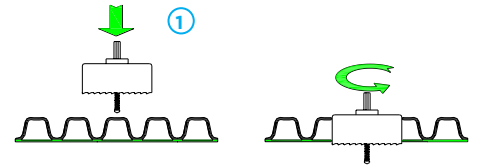

Insert sealing ring fully into hole.

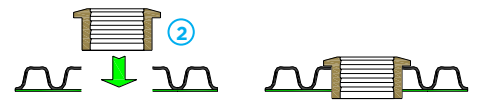

For branch pipes of 160mm and 200mm OD lube inside of sealing ring and insert the sealing adaptor.

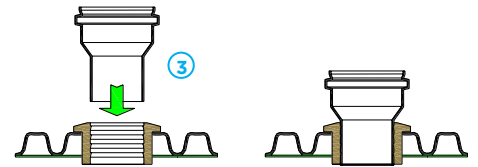

OR

If branch pipe is 110mm OD a sealing adaptor is not needed. Insert branch pipe directly into sealing ring.

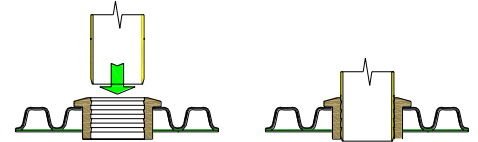

For a EUROFLO® branch pipe fit a rubber ring (as for a EUROFLO® pipe line watertight connection), and insert the pipe spigot, with the rubber ring installed, into the sealing adaptor.

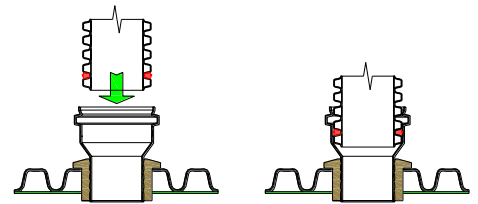

For a smooth PVC branch, fit a sealing adaptor rubber ring gasket onto the branch pipe, lubricate the sealing adaptor and then insert the branch pipe.

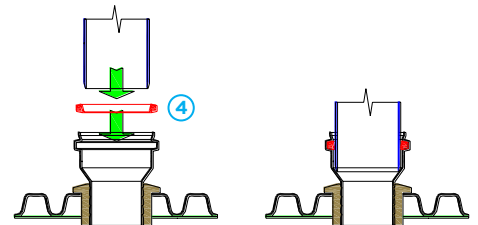

DN OF BRANCH PIPE IN MM

MINIMUM ID OF MAIN PIPE IN MM

110mm	250mm
160mm	350mm
200mm	400mm

GO-IN SYSTEM FITTINGS

HOLESAW AND ARBOR



SIZE	CODE	COMMENT
110mm OD	521-2431-110	Holesaw Only
110mm	521-2432-11	Arbor for Holesaw
160mm OD	521-2431-160	Holesaw Only
200mm OD	521-2431-200	Holesaw Only
160/200mm	521-2432-16	Arbor for Holesaw

Note: The correct sized holesaw and arbor both need to be purchased

SEALING RINGS



SIZE	CODE	COMMENT
110mm ID	521-2439-110	Fits DWV or stormwater pipe inside rubber
160mm ID	521-2439-160	Requires sealing adaptor 521-2430-160
200mm ID	521-2439-200	Requires sealing adaptor 521-2430-200

SEALING ADAPTORS



SIZE	CODE	COMMENT
160mm ID	521-2430-160	For use with sealing ring 521-2439-160
200mm ID	521-2430-200	For use with sealing ring 521-2439-200

SEALING ADAPTOR RUBBER RING GASKETS



SIZE	CODE	COMMENT
160mm	521-1301-160	For use when connecting PVC pipe into sealing adaptors
200mm	521-1301-200	

Key

All Item DWV unless noted
M+F = Male, Female Ends

DWV= Drain Waste and Vent
F+F= Female, Female Ends

SW= Storm Water
ADJ= Adjustable

EUROFLO® PIPE

SN4 EUROFLO® PIPE

- 5.8 metre lengths overall including socket
- Rubber ring joint if needed - see fittings page for codes for the rubber rings
- SN16 stiffness available to order



PRODUCT CODE	DESCRIPTION	SN RATING	CRATE QTY	NOMINAL BORE (MM)	OUTSIDE DIAMETER (MM)
520-160-5.8M	160mm Culvert Pipe EUROFLO®	SN8	33	150	160
520-200-5.8M	200mm Culvert Pipe EUROFLO®	SN4	18	180	200
520-250-5.8M	250mm Culvert Pipe EUROFLO®	SN4	11	220	250
520-315-5.8M	315mm Culvert Pipe EUROFLO®	SN4	6	280	315
520-400-5.8M	400mm Culvert Pipe EUROFLO®	SN4	3	350	400
520-500-5.8M	500mm Culvert Pipe EUROFLO®	SN4	2	430	500
520-630-5.8M	630mm Culvert Pipe EUROFLO®	SN4	1	530	630
520-800-5.8M	800mm Culvert Pipe EUROFLO®	SN4	1	640	800
520-1000-5.8M	1000mm Culvert Pipe EUROFLO®	SN4	1	850	1000
520-1200-5.8M	1200mm Culvert Pipe EUROFLO®	SN4	1	1030	1200

Notes: For pipe larger than 1200mm see SN8 pipe.
For exact bore measurements please see technical brochure.

FLUMING (HALF PIPE)

5.8 metre lengths overall including socket

PRODUCT CODE	DESCRIPTION
520-250-FLUM	250mm Fluming Half Pipe
520-315-FLUM	315mm Fluming Half Pipe
520-400-FLUM	400mm Fluming Half Pipe
520-500-FLUM	500mm Fluming Half Pipe
520-630-FLUM	630mm Fluming Half Pipe
520-800-FLUM	800mm Fluming Half Pipe
520-1000-FLUM	1000mm Fluming Half Pipe
520-1200-FLUM	1200mm Fluming Half Pipe



Key

All Item DWV unless noted
M+F = Male, Female Ends

DWV= Drain Waste and Vent
F+F= Female, Female Ends

SW= Storm Water
ADJ= Adjustable

SN8 EUROFLO[®] PIPE

- SN8 Rating
- 5.8 metre lengths overall including socket
- Rubber ring joint if needed - see fittings page for codes for the rubber rings



PRODUCT CODE	DESCRIPTION	SN RATING	CRATE QTY	NOMINAL BORE (MM)	OUTSIDE DIAMETER (MM)
560-250-5.8M	250mm Heavy Wall EUROFLO [®] pipe	SN8	11	220	250
560-315-5.8M	315mm Heavy Wall EUROFLO [®] pipe	SN8	6	280	315
560-400-5.8M	400mm Heavy Wall EUROFLO [®] pipe	SN8	3	350	400
560-500-5.8M	500mm Heavy Wall EUROFLO [®] pipe	SN8	2	430	500
560-630-5.8M	630mm Heavy Wall EUROFLO [®] pipe	SN8	1	530	630
560-800-5.8M	800mm Heavy Wall EUROFLO [®] pipe	SN8	1	673	800
560-1000-5.8M	1000mm Heavy Wall EUROFLO [®] pipe	SN8	1	850	1000
560-1200-5.8M	1200mm Heavy Wall EUROFLO [®] pipe	SN8	1	1030	1200
560-1300-5.8M	1300mm Heavy Wall EUROFLO [®] pipe	SN8	1	1200	1300
560-1500-5.8M	1500mm Heavy Wall EUROFLO [®] pipe	SN8	1	1400	1500
560-1700-5.8M	1700mm Heavy Wall EUROFLO [®] pipe	SN8	1	1600	1700
560-1900-5.8M	1900mm Heavy Wall EUROFLO [®] pipe	SN8	1	1800	1900
560-2100-5.8M	2100mm Heavy Wall EUROFLO [®] pipe	SN8	1	2000	2100

Note: for exact bore measurements please see technical brochure.

Key

All Item DWV unless noted
M+F = Male, Female Ends

DWV= Drain Waste and Vent
F+F= Female, Female Ends

SW= Storm Water
ADJ= Adjustable

EUROFLO® SLOTTED PIPE

5.8 metre lengths overall including socket

PRODUCT CODE	DESCRIPTION	CRATE QTY	NOMINAL BORE (MM)	OUTSIDE DIAMETER (MM)
590-160-5.8M	160mm Slotted Drainage Pipe	33	150	160
590-200-5.8M	200mm Slotted Drainage Pipe	18	180	200
590-250-5.8M	250mm Slotted Drainage Pipe	11	220	250
590-315-5.8M	315mm Slotted Drainage Pipe	6	280	315
590-400-5.8M	400mm Slotted Drainage Pipe	3	350	400
590-500-5.8M	500mm Slotted Drainage Pipe	2	430	500
590-630-5.8M	630mm Slotted Drainage Pipe	1	530	630

BENEFITS:

EUROFLO® Slotted Pipe allows you to fill in open drains without losing any ground drainage. Eliminate stock loses and comply with your environmental responsibilities to protect waterways.

- Quick and easy to lay, especially when compared to drain coil.
- Available in **LARGE DIAMETERS – up to 1200mm**
- Light and safe to handle
- Ideal replacement for old large diameter clay pipes
- Suits all standard PVC Bends, Y's, Tees, etc.
- Use economical EUROFLO® Go-In System to tee into larger diameter pipes

FEATURES:

- Strong and robust
- Subsoil drainage of surface and water table
- Will not rust
- Resist a wide range of chemicals from very acidic to very alkaline

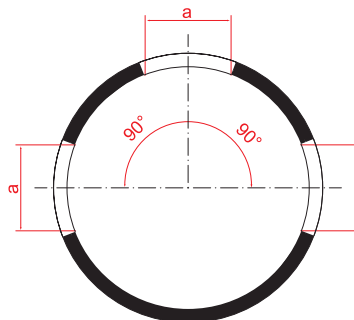

Standard Pattern

3-5 slots depending on size
Total slotted angle = 240°

SMOOTH BORE DRAINAGE PIPE



SIZE	CODE	COMMENT
110mm x 25m	UP110-025SB	Unpunched with draw string
110mm x 50m	UP110-050SB	Unpunched with draw string
110mm x 25m	P110-025SB	Punched
110mm x 50m	P110-050SB	Punched

Note: Filter sock and cloth available. See section H

DRAINAGE PIPE FITTINGS

Suits the following pipe brands:

- Smooth bore drainage pipe
- Drainaway
- Draincoil
- Novaflo
- EUROFLO[®] slotted pipe

PLAIN JUNCTIONS



SIZE	CODE	COMMENT
65mm x 45°	D04-65-45	Junction
65mm x 85°	D04-65-88	Junction
110mm x 45°	D04-110-45	Junction
110mm x 88°	D04-110-88	Junction
160mm x 110mm x 45°	D04-160-110-45	Reducing Junction
160mm x 110mm x 88°	D04-160-110-88	Reducing Junction
160mm x 45°	D04-160-45	Junction
160mm x 88°	D04-160-88	Square Junction

DOUBLE JUNCTIONS



SIZE	CODE	COMMENT
110mm x 88°	D06-110-88	Double Junction
160mm x 100mm x 45°	D06-160-110-45	Double Reducing Junction
160mm x 88°	D06-160-88	Double Junction

PLAIN COUPLING



SIZE	CODE	COMMENT
65mm	D10-65	Coupling
110mm	D10-110	Coupling
160mm	D10-160	Coupling

Key

All Item DWV unless noted
M+F = Male, Female Ends

DWV= Drain Waste and Vent
F+F= Female, Female Ends

SW= Storm Water
ADJ= Adjustable

